

EMC Regulations and Filter Specifications

ARCOTRONICS has filter design and development capability based in Great Britain together with our EMC test facilities in Italy, Germany, U.K. and in the U.S.A., assisting and advising customers on EMC solutions.

Capital investment has provided screened rooms in Italy, U.S.A. and a large anechoically lined test chamber in Great Britain, to offer a comprehensive Test & Advisory Service.

This catalogue is a summary of the extensive filter ranges produced by ARCOTRONICS.

Customer driven, filter design and development represents one of the strong points of ARCOTRONICS Advisory Service. A cost-effective solution to individual applications can be achieved by using measurements taken in our specialised laboratories. A graphical representation of the suppressed noise can be produced, by putting your equipment under test in our facility. Furthermore our laboratories, with computerised measuring equipment carry out RFI and EMI measurements from 20Hz to 1.3GHz to cover aspects of civil and military standards.

ARCOTRONICS can also test domestic appliances such as washing machines, dishwashers, ovens, etc, which may cause discontinuous interference.

In particular, ARCOTRONICS GROUP is equipped with the following instrumentation:

Emission Test Equipment

- Digital receivers for measurements of frequencies: from 20Hz up to 1300MHz.
- Analogue receivers for measurements of frequencies: from 80kHz up to 300MHz.
- Spectrum analyser for measurement of frequencies: from 100Hz up to 2200MHz.
- Analyser for impulsive discontinuous interference measurements (clicks).
- Generator of audio and TV digital functions: up to 1000MHz.
- Rod, loop, dipole, log-periodic and bi-conical antennae.

Immunity Test Equipment

- Static discharge simulator.
- Interference simulator system.

Please contact your local sales office for further information about our test facilities and services.

What is Radio Frequency Interference (RFI)?

"RFI" is classified as the undesirable electromagnetic energy in the range of frequencies, which are generally utilised for radio transmission. These may cause equipment malfunction either from interference on the power line or high frequency

radiated electromagnetic fields. The range of frequencies involved is from 10kHz to 30MHz for conducted interference and from 30MHz upwards for radiated interference and as a result video reception may be affected as well as radio.

Radio Interference Sources

The origin of RFI is always a rapid change in current or voltage. This sinusoidal distortion leads to rectangular or similar waveforms with harmonics along the whole frequency spectrum.

There are two main sources of "RFI"

1) Unintentional RFI.

This is a secondary effect of rapid variation of current or voltage in equipment as in a Switched Mode Power Supply (mechanical, electrical, electro-mechanical switches).

2) Intentional radio signals

(i.e. scientific and medical apparatus).

How the RFI sources are sub-divided

It is possible to distinguish two main groups of sources of interference by looking at the spectrum of emitted frequencies

Fig.1

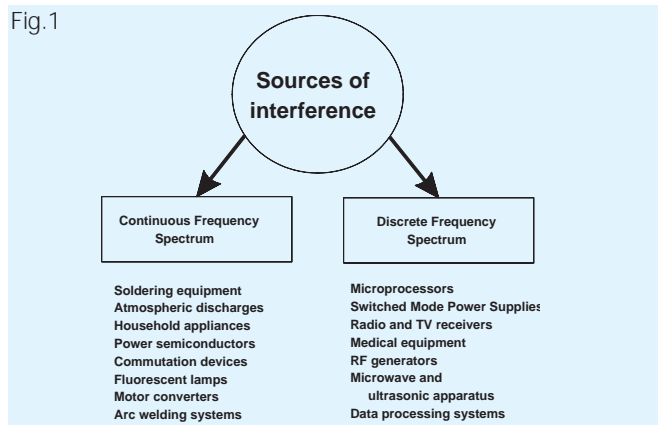

In turn, these equipments may themselves be affected by RFI (electromagnetic susceptibility).

Propagation of RFI

RFI propagation takes place in two ways:

- 1) by conduction (along the mains cable: generally for frequencies up to 30MHz).
- 2) by radiation (direct transmission, capacitive coupling, inductive coupling: generally for frequencies higher than 30MHz).

The interference current, which moves towards the affected equipment, along one side of the mains line and returns along the other to the source of the interference, is called differential or symmetric mode interference.

The interference current, which flows towards the apparatus from both the line cables and returns to the source of

interference via the earth cable, is called common or asymmetric mode interference.

The coupling of the equipment to the ground may be realised by the ground cable or through the stray capacitance (C_p) present in the same equipment generating or affected by the interference.

Capacitively coupled Radio-Interference decreases particularly at low and medium frequencies (Fig.2).

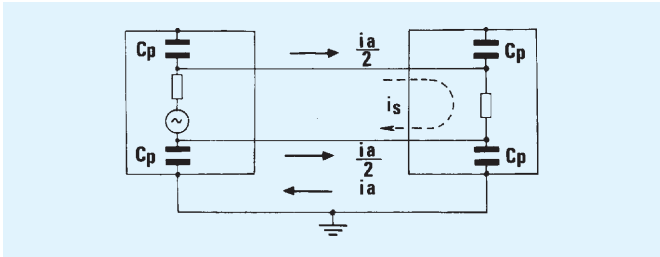

Fig.2
 i_s = differential mode interference current (symmetrical)
 i_a = common mode interference current (asymmetrical)
 C_p = stray capacitance

The propagation by radiation depends mainly on the physical size of the generator and the circuitry. Proper screening and correct grounding can reduce its intensity. In particular if an equipment's mains cable is longer or equal to $\lambda/4$ (where λ is the wavelength of the interference waveform), then stationary waves are generated along the cable which acts as a radiating antenna.

International limits and regulations for RFI

C.I.S.P.R. (Comite International Special des Perturbations Radio-electrique) is an internal committee of the I.E.C. (International Electrotechnical Commission) which publishes recommended methods for interference measures, measuring devices and radio interference limits. The national regulations bodies for radio interference generally have conformed to these recommendations.

Some CISPR recommendations:

1) CISPR 14 1993

Equipment with working frequency below 10kHz (broad band emission).
 Frequency range: 0.15MHz to 300MHz.
 e.g. electrical household appliances, portable instruments (power < 2kW) etc.
 Now encompassed in EN 55014-1 1997.

2) CISPR 11 1997

Equipment with working frequency above or equal to 10kHz.
 Frequency range: 0.01MHz to 1000MHz.
 e.g. ISM Equipment (Industrial, Scientific and Medical equipment).
 Now encompassed in EN 55011 1999.

3) CISPR 22 1993

Equipment for ITE (Information Technology Equipment).
 Frequency range: 0.15MHz to 1000MHz.
 e.g. personal computers, printers, monitors, etc
 Now encompassed in EN 55022-1 1998.

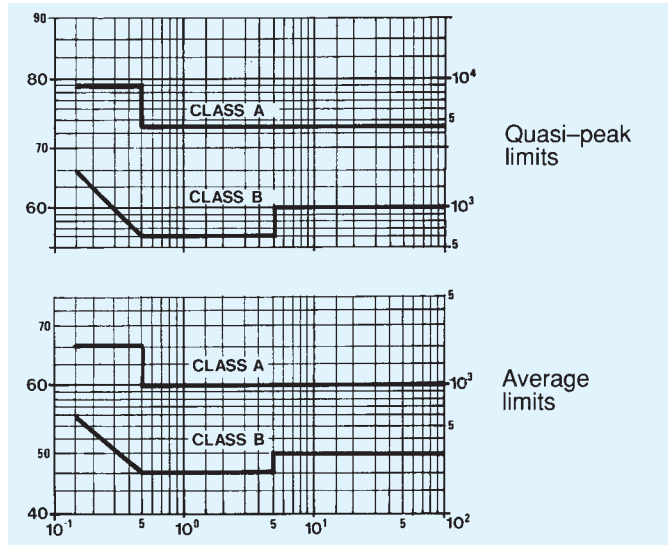

Fig.3

Fig.3 shows the values of maximum admissible levels of interference voltages according to CISPR 11 (ISM Apparatus) for conducted interference voltage produced on the mains.

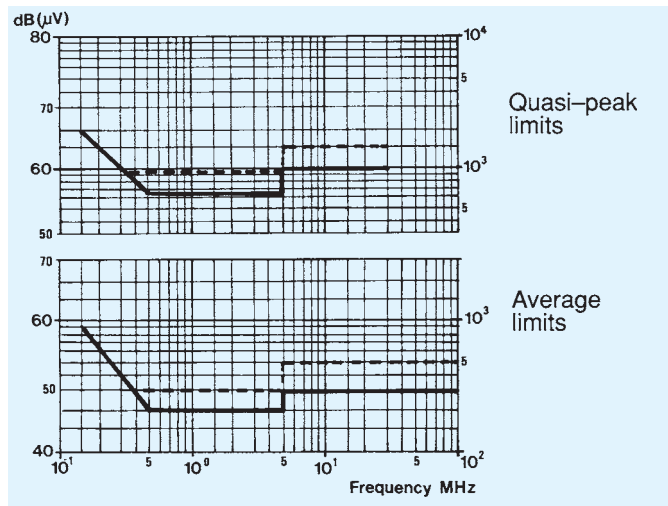

Fig.4 ——— Hand driven electric tools
 - - - - Household appliances

Fig.4 shows the values of maximum admissible levels of interference voltages according to CISPR 14 for conducted interference voltage produced on the mains.

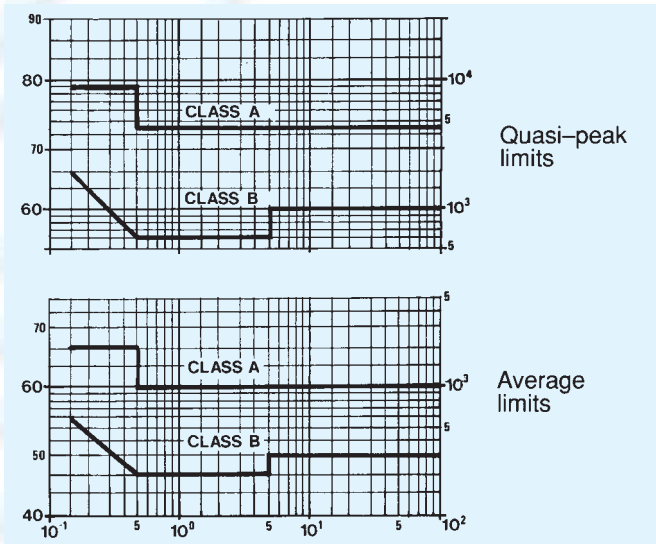

Fig.5

Fig.5 shows the maximum admissible levels of interference voltages according to CISPR 22 for conducted interference voltage produced on the mains.

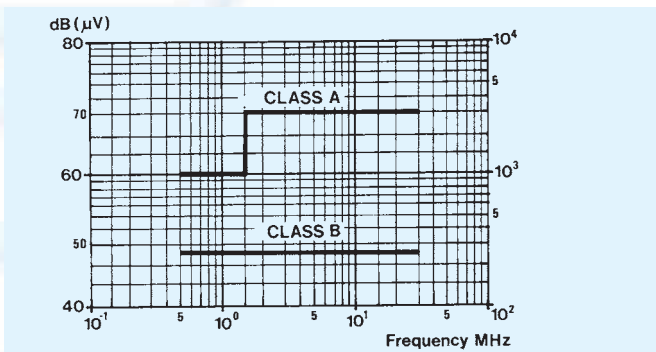

Fig.6

Fig.6 shows the maximum admissible levels of interference voltages according to FCC part 15 (sub-section J) for conducted interference voltage produced on the mains.

Purpose of the EMC directive

The European Community Cabinet has approved a set of new regulations relevant to electromagnetic compatibility (Directive 89/336/EEC & 92/31/EEC). These regulations came into force on 1st January 1996 to harmonise the present domestic legislation and to allow the free circulation of electrical and electronic devices inside the European community. CENELEC (European Committee for Electrotechnical standardisation) was entrusted to draw up these EMC standards. New Directive 2004/108/EC replaces 89/336/EEC from 20th July 2007. The equipment must fulfil the following requirements to be in compliance with the new regulations:

- a) Limited emission of EMI
- b) Adequate level of intrinsic immunity against EMI
(The concept of immunity is as important as emission).

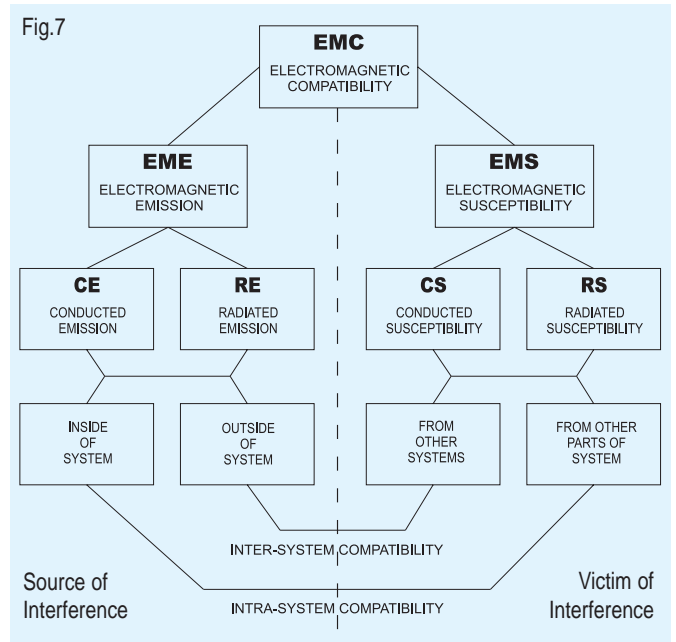

Fig.7 shows the EMC concept.

Methods for evaluating the test results, emission limits, and immunity levels are quoted on the European Standards EN ... issued by CENELEC. Restriction on free circulation at EC level will be applied if equipment is found not to be in compliance.

Measurement of Conducted Interference

Testing should be performed using:

- 1) a screened room, that allows measurement with the minimum amount of background noise.
- 2) a stabilisation network of the power line impedance, simulating the average conditions of the network impedance. (LISN - Line Impedance Stabilisation Network)
- 3) a receiver or spectrum analyser for measuring interference voltages (values in dB/µV).
- 4) an interference simulator.

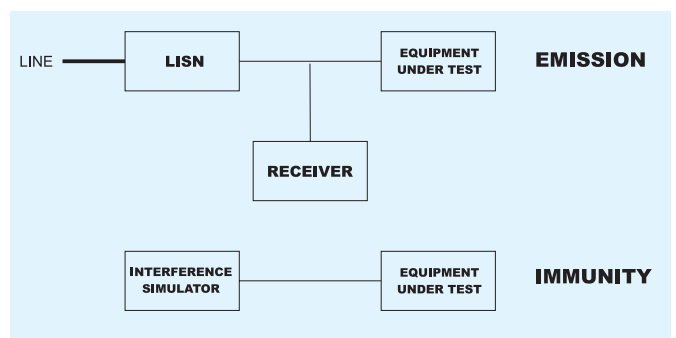

Fig.8

What is a RFI Power Line filter?

A RFI Power Line filter is one of the most important devices for controlling and suppressing unwanted, conducted RFI. It is used, by the designer of electronic equipment both to avoid outgoing interference getting onto the mains (when the equipment acts as an interference source) and to protect the equipment itself from incoming conducted RFI.

The RFI Power Line filter is a multiple-port network of passive components arranged as a dual low-pass filter. One network controls differential mode noise, the other attenuates common mode noise. By restricting outgoing conducted RFI, the filter also assists in reducing radiated emissions.

Being a low pass filter, it allows power current into the equipment unimpeded but attenuates RF energies (generally above 10kHz). The filter is positioned at the mains input to the equipment for the best effect.

What are the main components in a RFI Power Line filter?

A filter is essentially a "LC" network which creates an "impedance mismatch" at high frequencies causing incoming unwanted frequencies to be reflected back to the AC power network. Likewise if the equipment itself is generating noise (e.g. S.M.P.S.) some filters are designed to present a high impedance to the equipment and so control outgoing interference. Knowledge of the input impedance of the equipment may be useful information during the initial search for an ARCOTRONICS filter range suitable for your application. However since impedance varies with frequency a number of possible filters may have to be evaluated and their "in circuit" performance measured. ARCOTRONICS provides this service and with our extensive experience in this area, along with up-to-date automatic measuring equipment, we can help you choose the best filtering solution both technically and commercially.

Typical RFI filter circuit

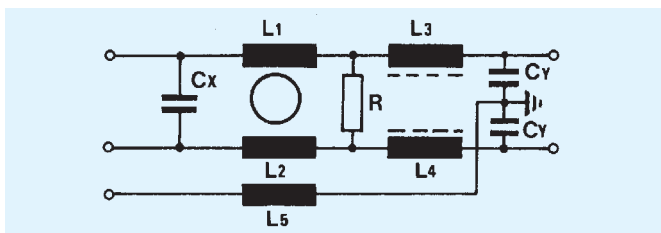

Fig.9

Normally L1 and L2 have relatively high inductance values (up to 40mH) giving a high common mode impedance (series inductance) and this produces an impedance mismatch with the low common-mode impedance of the power line.

L1 and L2 are wound on a single toroidal core with the two windings having the same number of turns and wound so that with a normal differential mode operating current the resulting magnetic fluxes in the toroid compensate each other. This avoids saturation of the core itself.

When considering common mode (asymmetric) interference, the two fluxes add together without causing core saturation.

This high inductive impedance mainly works at low frequencies.

Y class capacitors (Cy) are used between phase (or neutral) and earth to work at high frequencies. The Y class capacitors cannot have very high values because of limits set by national regulatory bodies with regard to equipment leakage current. The X class capacitors (Cx) are connected between phases and neutral, producing attenuation to differential (symmetric) interference.

Here the stray inductance's of L1 and L2 also have an additive effect.

In some of the more sophisticated filters, ARCOTRONICS uses non-compensated single chokes to improve the attenuation in the differential mode (L3 and L4) and in the common mode (L3, L4 and L5).

Resistor (R) is used in order to discharge Cx capacitors.

Also, to withstand large voltage spikes with fast rise times, over-voltage suppressor components like varistors or gas filled surge arrestors can be incorporated inside the filters upon request.

Measurement of a RFI Power Line filter attenuation

Since it is not possible to clearly define the impedance of the interference source or that of the affected equipment over the whole frequency range, then it is universally accepted to indicate the insertion loss (attenuation) measured in a system having well-defined impedance. The attenuation curves included in this catalogue refer to a typical impedance of 50Ω. The insertion loss is the result of the following formula:

$$I.L. (dB) = 20 \text{ Log}_{(10)} \frac{V_0}{2 \cdot V_2}$$

Where $V_0/2$ is the voltage at the terminals of a disconnected filter, and V_2 is the voltage at the output terminals of a connected filter.

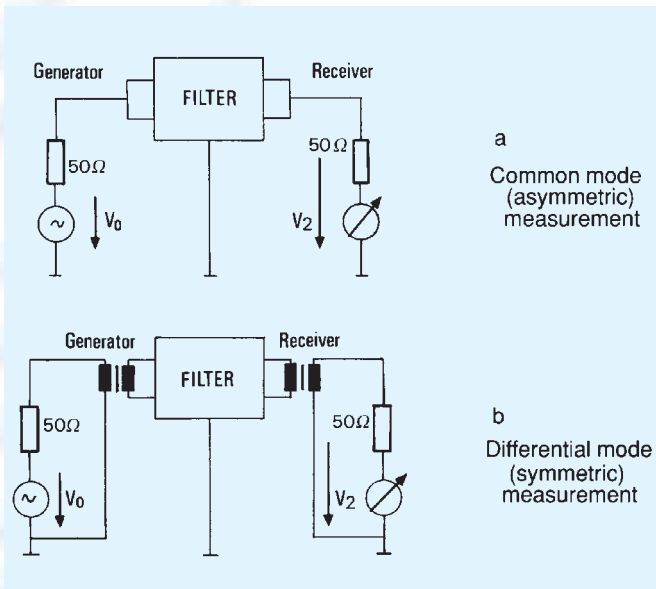

Fig.10

Fig.10 shows the measurement circuits.

In the common mode measurement, the signal present on both lines (phase and neutral) is referred to ground. Fig.10a shows the measurement carried out short-circuiting the line and neutral terminals on both sides of the filter. In the differential mode measurement, the signal present on one side of the line is referred to the other. Fig.10b shows the measurement carried out through RF transformers inserted between the RF signal generator and the inlet of the filter and between the outlet of the filter and the receiver.

General technical data

ARCOTRONICS filters are designed to work at a rated voltage in accordance with national and international standards. The working frequency is from D.C. to 60Hz. The nominal current depends on the ambient temperature. The data in this brochure relates to an ambient temperature of 40°C.

Fig.11 shows the ratio between the maximum permissible current and the ambient temperature for 85°C upper category temperature and 40°C ambient temperature.

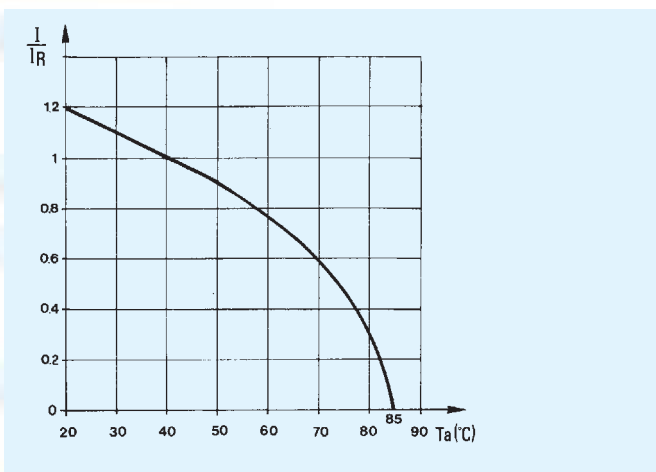

Fig.11

The formula used to generate the above curve is as follows:

$$I = I_R \cdot \sqrt{\frac{T_m - T_a}{T_m - T_R}}$$

where:

I = permissible current at ambient temperature

IR = Rated current

Tm = max permissible temperature (for filters normally 85°C)

Ta = ambient temperature

TR = temperature concerning the IR current (normally 40°C)

The climatic classes of our filters are in accordance to DIN 40040 and IEC 68. For example:

DIN 40040	IEC 68
H P F	25/085/21

- ▶ Humidity: 21(F); 56(C) days at 40°C with 95% R.H.
- ▶ Upper category temperature: +85 °C (P); +100 °C (M)
- ▶ Lower category temperature: -40°C (G); -25°C (H)

The upper category temperature gives the maximum ambient temperature at which the capacitors can work.

Therefore for filters using only capacitance the upper category temperature coincides with the maximum ambient temperature at which the filter can work. For the inductive-capacitive filters the upper category temperature identifies the maximum inside temperature of the filters used at an ambient temperature of 40°C when operating at the nominal load current.

Furthermore, some series are to the full military requirements, and are of a welded construction especially developed in the ARCOTRONICS Research Laboratories to meet the 125°C category temperature.

Tolerances of inductance and capacitance values

The inductance and capacitance values mentioned in this catalogue are nominal. If not otherwise specified, the tolerance for the inductance is -30% to +50% while for capacitance it is -20% to +20%.

Safety considerations and specifications

The capacitive components used in our filters are included in the following two groups, in compliance with EN 132400 and IEC 384 part 14 specifications:

X2 Class capacitors are connected between phases or between phases and neutral i.e. in a position where a possible fault cannot cause risk of electrical shock to the user.

Y2 Class capacitors are connected between phase or neutral

and the protective earth i.e. in a position where a possible fault could cause risk of electrical shock to the user.

Capacitance values of C_y capacitors are limited according to equipment specifications. Leakage current can represent a danger in case equipment loses the ground connection or if connected to ground by too high resistance (R_T) compared with human body (R_C). (Fig.12)

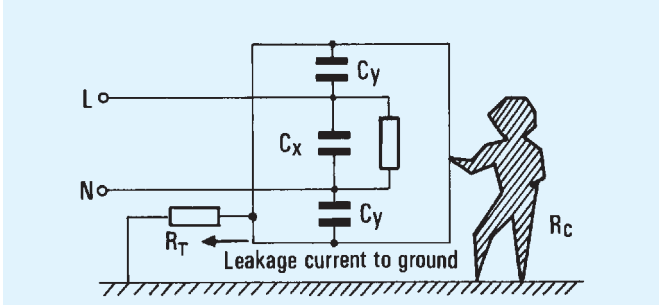

Fig.12
Besides the leakage current due to the filter, that associated with the equipment must be taken into account. All these currents are cumulative at the protective earth conductor. This total current cannot exceed the limit value, set by the safety specifications of the various national regulatory bodies and this depends on the type of equipment under consideration.

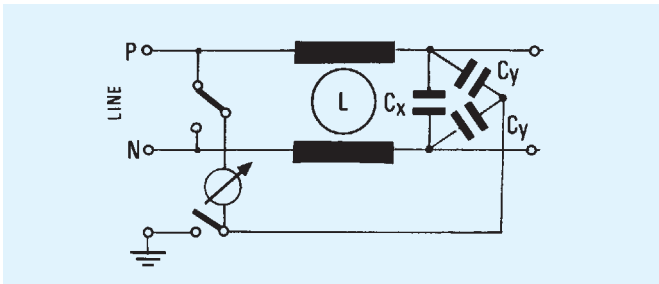

Fig.13
Data and measurement method relevant to leakage current of the equipment (including filter) are based on EN 60335-1. The formula for the approximate calculation of the maximum leakage current of a single-phase filter with a delta capacitive construction (Fig.13) is as follows:

$$I_L = 2 \pi f V (1.1) C_y (1.2)$$

V = rated voltage
 f = rated frequency

The equation above allows for a +20% tolerance on C_y and +10% tolerance allowance for a possible mains overvoltage. For three-phase filters the maximum leakage current is measured with one phase connected and all other phases disconnected. The equipment safety standards prescribe the discharge time limit of the total capacitance towards the supply main. For this reason the customer may choose the filter resistor value. Most of our filters with $\sum C_x > 0.1 \mu F$ are

supplied with a discharge resistor whose value is in compliance with IEC 335-1.

Fig.14 illustrates the most significant safety requirements of the main national regulatory bodies.

* LEAKAGE CURRENT					
Type of equipment	Insulation class	I max (mA)	V (Volt)	f (Hz)	Standard
Mobile	I	0.75	250	50	IEC 335-1 EN 60335-1 VDE 0700-1
Fixed	I	3.5	250	50	
Fixed heat	I	0.75/kW max 5	250	50	
All	0 OI III	0.5	250	50	
All	II	0.25	250	50	

*These leakage current limits apply to household appliances for general use.
For other appliances refer to relevant standards.

Country (Regulatory body)	Approval Mark	Test standard	High Voltage Test		
			kV (1 min.)	Hz	P→N P,N→E
ITALY (IMQ)		EN 133200	4.3V _R 1.8	0 50	P→N P,N→E
GERMANY (VDE)		EN 133200	4.3V _R 1.8	0 50	P→N P,N→E
U.S.A. (UL)		1283 ≤ 250VAC	1.768 1.5	0 60	P→N P,N→E
CANADA (CSA)		C22.2 No.8	4.3V _R 1.8	0 60	P→N P,N→E

Fig.14
Note: Though European National Standards maintain validity these will be withdrawn and wholly superseded by EN 133200.

Quality Assurance

All ARCOTRONICS filters are submitted to a final test of their electrical characteristics at the end of production (100% of the products) and to a sampling inspection by attribute according to MIL-STD-105D under the responsibility of the Quality Assurance Organisation.